

# Momo

Das Fahrrad für mehr Balance



Abb. Grundmodell 20“, zusätzlich mit 7-Gang-Nabenschaltung

- **Momo ist ein Therapiefahrrad, welches insbesondere das Balancetraining und die Mobilisierung von Kindern und Jugendlichen unterstützt.**
- Die Federkraft der Stützräder ist einfach einstellbar und kann den Fähigkeiten angepasst werden. Die Stützräder lassen sich starr einstellen, um zunächst Sicherheit und Vertrauen zu vermitteln. Im Verlauf der Therapie lassen sie sich bis zu sehr weich federnden Stabilisierungshilfen verstellen.
- Das vielseitige Zubehör der Momo-Serie ist auch mit dem Therapierad kompatibel. Hierdurch kann eine individuelle Ausstattung erfolgen.
- Das Momo Therapierad trainiert Balance, Koordination und Ausdauer
- Die Rahmengeometrie mit dem tiefen Einstieg und Schwerpunkt vereinfacht das Handling
- Antriebs- und Ausstattungsvielfalt ermöglichen individuelle Anpassungen
- Die extra tief angesetzten Stützräder ermöglichen sowohl eine dynamische Abstützung als auch eine starre Einstellung

## Technische Daten:

	12“	16“	20“	24“	26“
<b>Art. Nr.</b>	38 01 000	38 02 000	38 03 000	38 04 000	38 05 000
<b>Für Kinder im Alter von (Jahre):</b>	1 ½ – 3 ½	3 – 6	5 – 8	8 – 12	ab 12
<b>A *Pedal bis Oberkante Sattel min.:</b>	28 cm	42 cm	48 cm	57 cm	70 cm
<b>B Sattelstützrohr bis Vorderrohr:</b>	33 cm	39 cm	45 cm	53 cm	58 cm
<b>D Radstand:</b>	64 cm	76 cm	89 cm	104 cm	112 cm
<b>E Einstiegshöhe:</b>	16 cm	18 cm	20 cm	22 cm	23 cm
<b>C Länge über alles:</b>	99 cm	122 cm	148 cm	168 cm	178 cm
<b>Breite über alles:</b>	43 cm	52 cm	62 cm	71 cm	76 cm
<b>Leergewicht:</b>	10.5 kg	13 kg	15 kg	18 kg	20 kg
<b>Belastung max.:</b>	35 kg	50 kg	65 kg	100 kg	100 kg

\* Mass mit Standard-Sattelstütze und -Sattel

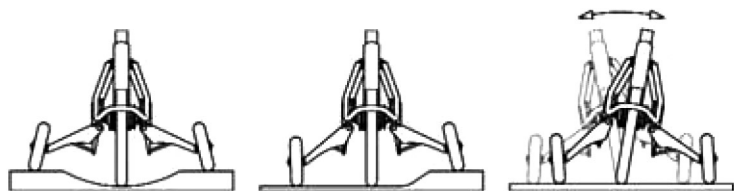
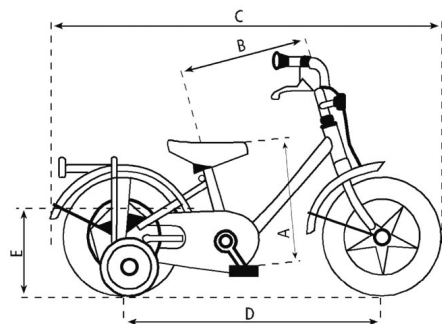

Die einstellbare Federstärke und die dynamisch arbeitenden Stützen sichern Traktion in jeder Fahrsituation und eine ausbalancierte Kurvenfahrt

**Das Grundmodell beinhaltet (weitere Informationen, siehe Bestellformular):**

- Farbwahl je nach Grösse (Melonengelb, Verkehrsrot, Marineblau, Weissaluminium, Reinweiss, weitere Farben auf Anfrage)
- Felgenbremse mit Feststellvorrichtung und Lenkungsdämpfer
- Trommelbremse im Vorderrad
- Stützradrahmen mit Federdämpfung zur Unterstützung des Gleichgewichtstrainings
- Freilaufbremsnabe mit Rücktrittbremse oder starrer Zahnkranz zum Rückwärtsfahren
- Standardsattel
- Standardsattelstütze
- Classic-Lenker
- Standardpedale
- Winkelverstellbarer Lenkervorbau
- Klingel
- Pumpe







Abb. Grundmodell 20", zusätzlich mit 7-Gang-Nabenschaltung

**Ausrüstungsvarianten / Zubehör:**



**Antrieb**

<b>Starrer Zahnkranz zum Rückwärtsfahren</b> Art. Nr. 38 00 001 <b>Freilaufbremsnabe (Rücktrittbremse)</b> Art. Nr. 38 00 101 <b>Extra leichte Übersetzung für alle Antriebsarten</b> Art. Nr. 38 00 002	<b>3-Gang-Freilaufbremsnabe (Rücktrittbremse)</b> Art. Nr. 38 00 003 <b>3-Gang-Leerlaufnabe (ohne Rücktrittbremse)</b> Art. Nr. 38 00 004 <b>3-Gang-Nabe mit Rückfahr-option/Rücktrittbremse</b> Art. Nr. 38 00 007	<b>7-Gang-Freilaufbremsnabe (Rücktrittbremse)</b> Art. Nr. 38 00 005 <b>7-Gang-Leerlaufnabe (ohne Rücktrittbremse)</b> Art. Nr. 38 00 006
---	--	--

**Sattel**

 <p><b>Gelsattel</b></p> <p>Gr. 1 Art. Nr. 37 01 024 Gr. 2 Art. Nr. 37 02 024</p>	 <p><b>Sattelsitz</b> mit extra breiter Sitzfläche</p> <p>Gr. 1 Art. Nr. 37 01 003 Gr. 2 Art. Nr. 37 02 003</p>	 <p><b>Einradsattel - Bananenform</b></p> <p>Art. Nr. 37 00 010</p>	 <p><b>Mofasattel</b></p> <p>Art. Nr. 37 00 023</p>
--	--	---	--



**Sattelstützen und Begrenzer**

 <p><b>T-Sattelstütze</b> zur horizontalen Verstellung des Sattels</p> <p>für Gr. 12" Art. Nr. 37 01 005 für Gr. 16" + 20" Art. Nr. 37 02 005 für Gr. 24" + 26" Art. Nr. 37 03 005</p>	 <p><b>Lenkeinschlagsbegrenzer</b> einstellbar bis zur Richtungsfeststellung</p> <p>für Gr. 12" Art. Nr. 37 01 006 für Gr. 16"-26" Art. Nr. 37 03 006</p>
---	--





## Rumpfstützen

 <p><b>Aufnahmebügel</b> (nur in Verbindung mit einer T-Sattelstütze nutzbar)</p> <p>Gr. 1, Höhe* 28 cm      Art. Nr. 37 01 007          Gr. 2, Höhe* 38 cm      Art. Nr. 37 02 007          Gr. 3, Höhe* 45 cm      Art. Nr. 37 03 007          Gr. 4, Höhe* 60 cm      Art. Nr. 37 04 007</p> <p>*Max. Höhe, gemessen Sattel bis Oberkante Rückenpelotte</p>	 <p><b>Dynamische Rückenpelotte</b>, gepolstert mit Gurt und Halterung (nur in Verbindung mit nebenstehendem Aufnahmebügel nutzbar)</p> <p>Gr. 1, Breite 20 – 30 cm      Art. Nr. 37 01 008          Gr. 2, Breite 25 – 35 cm      Art. Nr. 37 02 008          Gr. 3, Breite 30 – 40 cm      Art. Nr. 37 03 008</p>	 <p><b>Breitenverstellbare Rückenpelotte</b>, gepolstert inkl. Halterung (nur in Verbindung mit nebenstehendem Aufnahmebügel nutzbar)</p> <p>Gr. 1, Breite 15 – 23 cm      Art. Nr. 37 01 025          Gr. 2, Breite 20 – 28 cm      Art. Nr. 37 02 025          Gr. 3, Breite 24 – 34 cm      Art. Nr. 37 03 025</p>
---	--	--

## Beckenstützen

 <p><b>Dynamische Beckenführungspelotte</b>, gepolstert mit Gurt und Halterung (nur in Verbindung mit o. g. Aufnahmebügel nutzbar)</p> <p>Gr. 1, Breite 20 – 30 cm      Art. Nr. 37 01 009          Gr. 2, Breite 25 – 35 cm      Art. Nr. 37 02 009          Gr. 3, Breite 30 – 40 cm      Art. Nr. 37 03 009</p>	 <p><b>Breitenverstellbare Beckenführungspelotte</b>, gepolstert inkl. Halterung (nur in Verbindung mit o. g. Aufnahmebügel nutzbar)</p> <p>Gr. 1, Breite 15 – 23 cm      Art. Nr. 37 01 026          Gr. 2, Breite 20 – 28 cm      Art. Nr. 37 02 026          Gr. 3, Breite 24 – 34 cm      Art. Nr. 37 03 026</p>
---	---

## Begurtungssystem

 <p><b>Brustgurt</b> für die o. g. breitenverstellbare Rückenpelotte</p> <p>Gr. 1 Art. Nr. 37 01 050          Gr. 2 Art. Nr. 37 02 050          Gr. 3 Art. Nr. 37 03 050</p>	 <p><b>Fixationsweste</b> für die o. g. breitenverstellbare Rückenpelotte</p> <p>Gr. 1 Art. Nr. 37 01 051          Gr. 2 Art. Nr. 37 02 051          Gr. 3 Art. Nr. 37 03 051</p>	 <p><b>Sitzhose T-Form</b> für die o. g. breitenverstellbare Beckenpelotte</p> <p>Gr. 1 Art. Nr. 37 01 052          Gr. 2 Art. Nr. 37 02 052          Gr. 3 Art. Nr. 37 03 052</p>	 <p><b>4-Punkt-Beckengurt</b> für die o. g. breitenverstellbare Beckenpelotte</p> <p>Gr. 1 Art. Nr. 37 01 053          Gr. 2 Art. Nr. 37 02 053          Gr. 3 Art. Nr. 37 03 053</p>	 <p><b>Handfixierung</b> für die untenstehenden Lenker</p> <p>Gr. 0 Art. Nr. 37 00 054          Gr. 1 Art. Nr. 37 01 054          Gr. 2 Art. Nr. 37 02 054          Gr. 3 Art. Nr. 37 03 054</p>
---	--	---	--	---

## Lenker

 <p><b>Touringlenker</b></p> <p>Gr. 1 Art. Nr. 37 01 012          Gr. 2 Art. Nr. 37 02 012</p>	 <p><b>Rundlenker</b></p> <p>Gr. 1 Art. Nr. 37 01 013          Gr. 2 Art. Nr. 37 02 013</p>	 <p><b>Multifunktionslenker</b> geeignet für die Grössen 3/4/5</p> <p>Art. Nr. 37 02 014</p>	 <p><b>Vorbauverlängerung</b> Länge 10 cm</p> <p>für 12" Art. Nr. 37 01 022          für 16" – 26" Art. Nr. 37 02 022</p>
---	--	--	--

## Schiebestange

<p><b>Schiebestange</b> höheninstellbar und abnehmbar mit integrierter Verdrehsicherung</p>  <p>für 12" Art. Nr. 38 01 009 für 16" Art. Nr. 38 02 009 für 20" – 26" Art. Nr. 38 03 009</p>	<p><b>Lenkung für Begleitperson</b> per Umlenkgestänge mittels nebenstehender Schiebestange</p> <p>für 12" Art. Nr. 38 01 010 für 16" Art. Nr. 38 02 010 für 20" Art. Nr. 38 03 010</p>	<p><b>Feststellbremse für Begleitperson</b> in Verbindung mit nebenstehender Schiebestange</p> <p>Art. Nr. 38 00 011</p>
---	---	--

## Kurbel

 <p><b>Stufenlos einstellbare Kurbelverkürzer für die Gr. 12" – 20"</b>, hierdurch keine Verbreiterung des Pedalabstandes</p> <p>Einheit: Paar Art. Nr. 37 01 015</p>	 <p><b>Kurbelverkürzer</b>, minimale Verbreiterung des Pedalabstandes</p> <p>Einheit: Paar für 16" + 20" Art. Nr. 37 02 015 für 24" + 26" Art. Nr. 37 05 015</p>	 <p><b>Spezialkurbel für Kniekontraktur</b></p> <p>Rechts montiert Art. Nr. 37 03 015 Links montiert Art. Nr. 37 04 015</p>
--	---	--

## Pedale

 <p><b>Fussfixierpedale</b> mit Rennhaken und Ausgleichsgewichten</p> <p>Einheit: Paar Art. Nr. 37 00 013</p>	 <p><b>Heimtrainerpedale</b></p> <p>Einheit: Paar Art. Nr. 37 00 014</p>	 <p><b>Fusschalen</b>, breitenverstellbar mit Ausgleichsgewichten und Fixiergurten</p> <p>Einheit: Paar Gr. 1 Art. Nr. 37 01 017 Gr. 2 Art. Nr. 37 02 017 Gr. 3 Art. Nr. 37 04 017</p>	 <p><b>Fusschalen mit Beinführung</b>, breitenverstellbar und Fixiergurten</p> <p>Einheit: Paar Gr. 1 Art. Nr. 37 01 018 Gr. 2 Art. Nr. 37 02 018 Gr. 3 Art. Nr. 37 03 018 Gr. 4 Art. Nr. 37 04 018</p>
--	---	--	--

## Sonstiges

<p><b>Aufrüstung einer Lichtenanlage und Reflektoren für die Gr. 2/3</b></p> <p>Art. Nr. 37 01 021</p>	<p><b>Lichtenanlage mit Nabendynamo für die Gr. 4/5</b> (Lichtenanlage mit Standarddynamo inkl.)</p> <p>Art. Nr. 37 04 021</p>	<p><b>Korb</b></p> <p>für 12" + 16" Art. Nr. 38 01 019 für 20" + 24" Art. Nr. 38 03 019 für 26" Art. Nr. 38 05 019</p>	<p><b>Schnellverbindung des Stützradrahmens</b> zur einfachen Demontage für den Transport</p> <p>für 12" Art. Nr. 38 01 26 für 16" - 26" Art. Nr. 38 02 26</p>
<p><b>Anfahrhilfe per Elektroantrieb</b> mittels Drehgriff durch den Fahrer. inkl. 36V Lithium Ionen Akku 5,2AH</p> <p>max. Geschwindigkeit ca. 3,2 km/h</p> <p>für 16" Art. Nr. 38 02 025 für 20" Art. Nr. 38 03 025</p>	<p><b>Aktiver Elektroantrieb per Radnabenmotor</b> inkl. Anfahrhilfe mittels Drehgriff und Tretsensor. inkl. 36V Lithium Ionen Akku</p> <p>5,2AH, max. Geschwindigkeit ca. 20 km/h</p> <p>für 24" Art. Nr. 38 04 025 für 26" Art. Nr. 38 05 025</p>	<p><b>Stützradrahmen mit Federdämpfung</b> zur Unterstützung des Gleichgewichtstraining als Montagesatz</p> <p>für 12" Art. Nr. 38 01 101 für 16" Art. Nr. 38 02 101 für 20" Art. Nr. 38 03 101 für 24" Art. Nr. 38 04 101 für 26" Art. Nr. 38 05 101</p>	<p><b>Montage des Stützradrahmens im Hause Schuchmann</b></p> <p>Art. Nr. 38 00 025</p>